

# MSD Servo Drive

Software User Manual

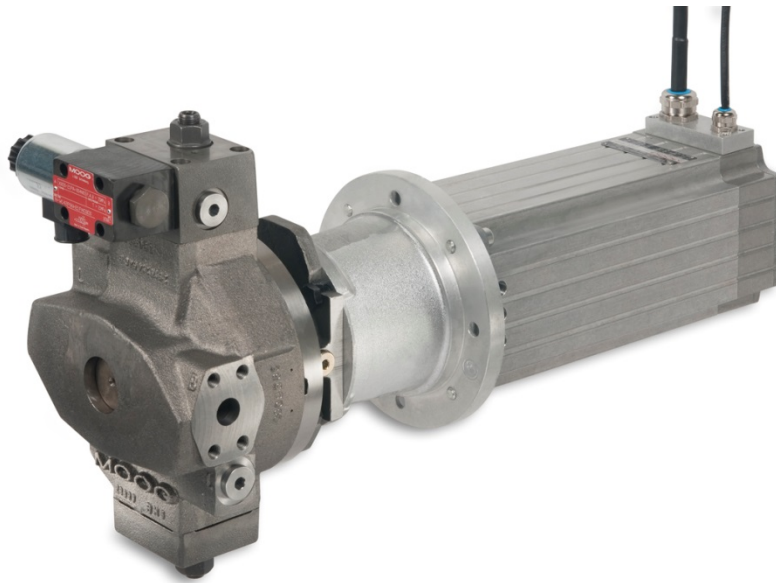

Speed Controlled Pump  
With Pressure Limiting Controller



## SCP Software User Manual

Id no.: CB90332-001, Rev. 1.1

Date: 02/2017

The English version is the original of this specification

## Technical alterations reserved

The contents of our documentation have been compiled with greatest care and in compliance with our present status of information.

Nevertheless we would like to point that this document cannot always be updated parallel to the technical further development of our products.

Information and specifications may be changed at any time. For information on the latest version please refer to [drives-support@moog.com](mailto:drives-support@moog.com).

# Table of Contents

- 1 System description ..... 4
  - 1.1 Introduction .....4
  - 1.2 Overall View of SCP Controller .....4
- 2 Software and Parameter description ..... 5
  - 2.1 Installation .....5
  - 2.2 Software Overview .....6
  - 2.3 Parameter List Description .....7
- 4 Basic controller setup ..... 13
  - 4.1 Preparation for Setup .....13
  - 4.2 Main Parameters .....14
- 5 Advanced Controller Features..... 18
  - 5.1 Linearization .....18
  - 5.2 Dual Displacement.....19
  - 5.3 Parameter Switching Function .....20
  - 5.4 Protect Features .....21
  - 5.5 Actual Value Path .....22
  - 5.6 Cable Break Detection .....23
  - 5.7 Leakage Compensation .....24
  - 5.8 Additional Options.....24

## Audience

This document does not replace the MSD Servo Drive Operation Manual. Please be sure to observe the information contained in the “For your safety”, “Intended use” and “Responsibility” sections of the Operation Manual (ID no.: CA65642-001). For information on installation, setup and commissioning, and details of the warranted technical characteristics of the MSD Servo Drive series, refer to the additional documentation (Operation Manual, User Manual, etc.).

### This document provides information about

The Speed Controlled Pump (SCP) with pressure limiting controller Software. The aim is to provide an introduction into the features of SCP and corresponding controller parameters. The installation of the SCP hardware and setup of the drive as well as setup of the current and classical speed controller is not the subject of this User manual.

### Versions

This document relates to software version 60033 (based on Firmware 123.50-87) from April 5<sup>th</sup>, 2013. The software version can be read using the DRIVEADMINISTRATOR, viewing parameter **P 0048.4**.

### Referenced Documents

Title	Document No. (English)	Document No. (German)
MSD Servo Drive - Device Help	CB40859-001	CB40859-002
DRIVEADMINISTRATOR Manual	CA79186-001	CA79186-002
MSD Servo Drive Operation Manual	CA65642-001	CA65642-002
AIO Option Card Manual	CB59508-001	-

### Abbreviations

Abbreviation	Full Name
RKP	Radial Piston Pump
SCP	Speed Controlled Pump
NVM	Non Volatile Memory (Flash Memory)
PID	proportional-integral-derivative

## 1 System description

### 1.1 Introduction

The SCP system includes a Radial Piston Pump, a Servo Motor and a Servo Drive controlling the motor.

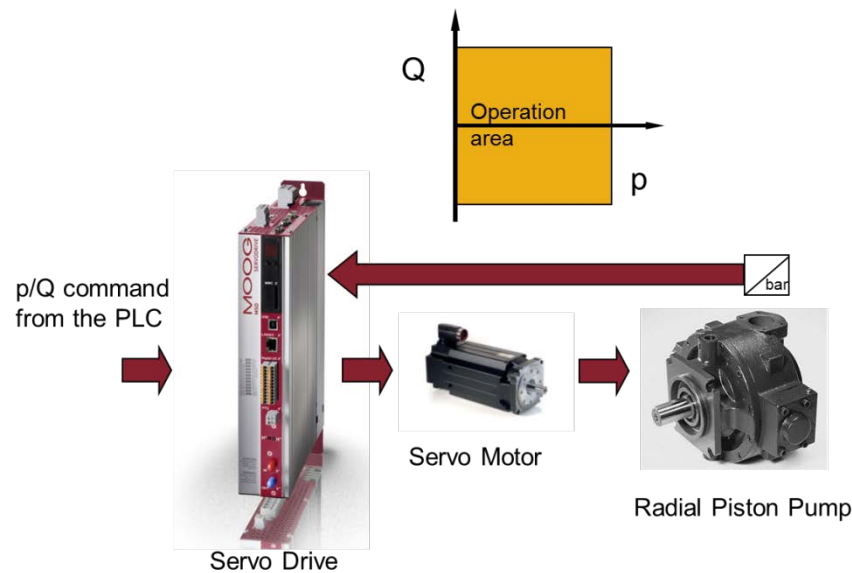

Fig. 1.1 Moog Speed Controlled Pump System SCP

The Software is developed to control pressure and flow of the SCP, depending on set point, working point and parameterization.

### 1.2 Overall View of SCP Controller

The main SCP controller structure is based on cascaded PID control principle. There are two coupled controllers, one for flow and one for pressure.

An anti-wind-up structure, an observer and advanced protection features are also implemented.

This document does not describe the internal control loops for the motor, like current control and speed control loop. They are not part of this documentation (see MSD Servo Drive Operation Manual).

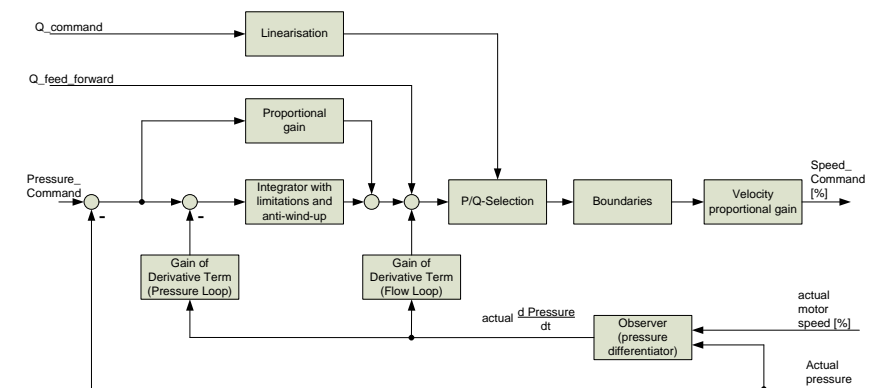

Fig. 1.2 Overall View of SCP Controller



**NOTE:** The observer represents a differentiator term. It can be used in two ways, depending on parameters. The first way: the observer works as a usual D term. It differentiates actual pressure. The second one: it can also work as a predictor to provide differentiated values without time delay.

The main controller features are presented in the following table.

Feature Title	Description
Feed forward	A Flow feed forward is implemented.
Linearization	The nonlinearity between speed and flow of the pump can be compensated.
Dual flow	A pump with dual displacement can be used.
Leakage compensation	The leakage of the pump can be compensated directly in the controller.
Cavitation protect	The risk of cavitation can be detected to protect the system.
Integrator anti-wind-up	The integral part of the controller has an anti-wind-up functionality.
Limitations	The controller is able to limit the pump speed and acceleration in different ways. It is also possible to define different limitations for different working points (e.g. depending on the sign of acceleration and velocity).
Parameter set switching	There are 15 parameter sets available in the controller. The controller can switch between them in real time, to fulfill the actual needs of the process.
Actual value input	The input channel for the actual values is selectable. Possibilities for combining and filtering of the inputs are implemented.
Cable break detection	A break of the cables will be detected.

Table 1.1 Main Software Features

## 2 Software and Parameter description

### 2.1 Installation

The SCP software is a fully integrated part of the MSD firmware and comes along with its own DRIVEADMINISTRATOR View. The new firmware can be installed like any other MSD firmware. Please note that all parameters (so e.g. the motor parameters) are set to default values during the installation. If the actual parameter setting should be kept, it needs to be saved before the firmware upgrade. For a detailed description how to upgrade the drive firmware please refer to MSD Servo Drive Operation Manual.

It is highly recommended to install a new DRIVEADMINISTRATOR View before working with the SCP software. After installation the DRIVEADMINISTRATOR will be upgraded with a new entry in the project tree. All SCP parameters are grouped under this entry.

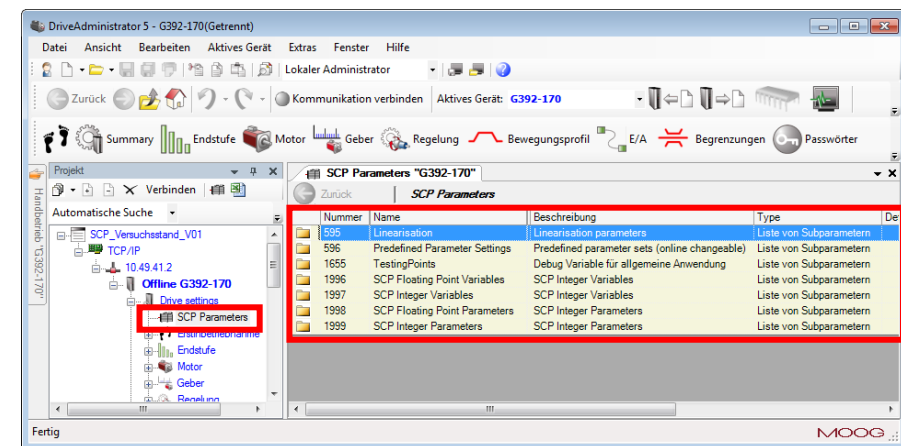

Fig. 2.1 DRIVEADMINISTRATOR View

### 2.2 Software Overview

All calculations in the SCP controller are in percentage. The output of the SCP controller is a velocity set point to the motor controller. Therefore the motor controller for current and speed should be set up before tuning the SCP controller. (see MSD Servo Drive Operation Manual).

The SCP parameters are grouped in several groups. Every group has several Sub-IDs. There is no graphical input mask for SCP parameters. The following table summarizes the parameter groups.

Group ID	Name	Description
<b>P 595</b>	Linearization	Linearization parameters
<b>P 596</b>	Predefined Parameter Settings	Predefined parameter sets (online changeable)
<b>P 1655</b>	Test Points	General purpose debug variables
<b>P 1996</b>	SCP Floating Point Variables	SCP Integer Variables
<b>P 1997</b>	SCP Integer Variables	SCP Integer Variables
<b>P 1998</b>	SCP Floating Point Parameters	SCP Integer Parameters
<b>P 1999</b>	SCP Integer Parameters	SCP Integer Parameters

Table 2.1 Parameter Groups



Attention: All parameters are immediately active after changing in the Moog DRIVEADMINISTRATOR. Change the parameters with care if the control is active!

The following chapter provides the overview and description of the parameters.

## 2.3 Parameter List Description

### SCP Floating Point Variables

Address	Name	Description	Unit	Type	Scope	Default	Range	Stored in Flash
P 1996.0	Pressure_command	Pressure command input	%	float	yes	3.0	0 - 100	no
P 1996.1	Q_command_input	Q command input	%	float	yes	0	- 100 - 100	no
P 1996.2	Q_feed_forward_input	Q feed forward input	%	float	yes	0	- 100 - 100	no
P 1996.3	Proportional_Gain	Proportional gain; pressure loop	-	float	yes	0	-1000 - 1000	no
P 1996.4	Derivative_Gain	Differentiator gain; flow loop	-	float	yes	0	-10 - 10	no
P 1996.5	Derivative_t	Differentiator time value; flow loop	ms	float	yes	0	0-10000000	no
P 1996.6	Derivative_I_Gain_Pos	Differentiator positive gain; pressure loop	-	float	yes	0,01	-max - max	no
P 1996.7	Derivative_I_Gain_Neg	Differentiator negative gain; pressure loop	-	float	yes	0,01	-max - max	no
P 1996.8	Derivative_I_t	Differentiator time value; pressure loop	ms	float	yes	2	0-10000000	no
P 1996.9	I_Gain	Integrator gain	1/s	float	yes	10	-10 <sup>8</sup> - 10 <sup>8</sup>	no
P 1996.10	P_Integrator_Feedback	Integrator feedback gain	-	float	yes	0	-10 <sup>5</sup> - 10 <sup>5</sup>	no
P 1996.11	Q_Command_Min_Static	Minimum flow; flow and pressure control	%	float	yes	-100	-100 - 100	no
P 1996.12	Derivative_Observer_Gain	Gain of observer input at differentiators	-	float	yes	0	-10 - 10	no

Table 2.2 Parameter Groups



Attention: Changes in the SCP Floating Point Variables wouldn't be saved. To save the parameters please use the predefined parameter sets (see below).

### Test Points

Address	Name	Description	Unit	Type	Scope	Default	Range	Stored in Flash
P 1655.0	tst00_Pressure_Command	Test point 00	%	float	yes	n/a	full range	no
P 1655.1	tst01_Q_Command	Test point 01	%	float	yes	n/a	full range	no
P 1655.2	tst02_Q_Command_Compens.	Test point 02	%	float	yes	n/a	full range	no
P 1655.3	tst03_Pressure_Actual	Test point 03	%	float	yes	n/a	full range	no
P 1655.4	tst04_Integrator_Input	Test point 04	%	float	yes	n/a	full range	no
P 1655.5	tst05_Integrator_Output	Test point 05	%	float	yes	n/a	full range	no
P 1655.6	tst06_Pressure_Compens._Out	Test point 06	%	float	yes	n/a	full range	no
P 1655.7	tst07_pQ_Selection_Output	Test point 07	%	float	yes	n/a	full range	no
P 1655.8	tst08_Speed_Command	Test point 08	%	float	yes	n/a	full range	no
P 1655.9	tst09_Actual_Speed	Test point 09	%	float	yes	n/a	full range	no
P 1655.10	tst10_Dual_Displace_p-factor	Test point 10	%	float	yes	n/a	full range	no
P 1655.11	tst11_Dual_Displace_Q-factor	Test point 11	%	float	yes	n/a	full range	no
P 1655.12	tst12_ACC_Rate_limit_Active	Test point 12	%	float	yes	n/a	full range	no
P 1655.13	tst13_ACC_Limitation_Input	Test point 13	%	float	yes	n/a	full range	no
P 1655.14	tst14_Differentiator_Ouput	Test point 14	%	float	yes	n/a	full range	no
P 1655.15	tst15_Differentiator_I_Output	Test point 15	%	float	yes	n/a	full range	no

Table 2.3 Test Point



### SCP Floating Point Parameters

Address	Name	Description	Unit	Type	Scope	Default	Range	Stored in Flash
P 1998.0	DD_Q_factor	Dual displacement Q factor		- float	yes	1	1 ... 100	yes
P 1998.1	DD_p_factor	Dual displacement p factor		- float	yes	1	1 ... 100	yes
P 1998.2	Actual_Value_Path_Factor [0-1]	Weighting two input paths		- float	yes	0	0 ... 1	yes
P 1998.3	Cable_Break_Threshold_ISA0	Cable break detection threshold. The percentage value is based on 10 V / 20 mA. For details how to set up the 4 .. 20 mA input please refer to MSD Servo Drive Operation Manual.		% float	yes	0	0 ... 10	yes
P 1998.4	Cable_Break_Threshold_ISA1	Cable break detection threshold. The percentage value is based on 10 V / 20 mA. For details how to set up the 4 .. 20 mA input please refer to MSD Servo Drive Operation Manual.		% float	yes	0	0 ... 10	yes
P 1998.5	I_MAX_Offset	Integrator positive limit offset		% float	yes	1	0 ... 100	yes
P 1998.6	I_MAX_min	Integrator limitation		% float	yes	0	-1000 ... 1000	yes
P 1998.7	I_MAX_max	Integrator limitation		% float	yes	100	-1000 ... 1000	yes
P 1998.8	I_MIN_min	Integrator limitation		% float	yes	-100	-1000 ... 1000	yes
P 1998.9	I_MIN_max	Integrator limitation		% float	yes	0	-1000 ... 1000	yes
P 1998.10	Speed_Rise_Rate_1	Maximum change of motor speed command		% / s float	yes	5000	1 ... 10 <sup>6</sup>	yes
P 1998.11	Speed_Rise_Rate_2	Maximum change of motor speed command		% / s float	yes	5000	1 ... 10 <sup>6</sup>	yes
P 1998.12	Velocity_Gain	Motor velocity gain scaling		RPM per [%] float	yes	0	-100 ... 100	yes
P 1998.13	Pressure_Cavitation_Limit	Pressure cavitation limit		% float	yes	3	0 ... 100	yes
P 1998.14	Leakage_Compensation	Q cmd mod = Q cmd + pressure * leakage comp'		%speed / %pressure float	yes	0	0 ... 1000	yes
P 1998.15	Cavitation_Minimum_Velocity	Minimum velocity @ cavitation		% float	yes	0	-100 ... 100	yes

Table 2.4 SCP Floating Point Parameters

## SCP Integer Variables

Address	Name	Description	Unit	Type	Scope	Default	Range	Stored in Flash
P 1997.0	Predefined_Parameter_Switch	Switching between predefined parameter data sets	[ ]	int	yes	Set 0 [0]	0 ... 14	no
P 1997.1	SCP_StatusWord	Status of pressure controller  0 = flow limitation effective 1 = pressure controller effective	[ ]	int	yes	n/a	full range	no
P 1997.3	DD_ON_OFF	Dual displacement factors active	list	int	yes	off	[0, 1]	no

Table 2.5 SCP Integer Variables

## Linearization

Address	Name	Description	Name	Description	Unit	Type	Scope	Default	Range	Stored in Flash
P 595.0	Linearisation_Number_Elements	Number of elements	Linearisation_Number_Elements	Number of Elements	[ ]	int	no	0	0 .. 10	yes
P 595.1-10	Linearisation_Input_1 - 10	Look up table Input	Linearisation_Input_1 - 10	Look up table Input	%	int	no	0	-100.. 100	yes
P 595.11-20	Linearisation_Output_1 - 10	Look up table output	Linearisation_Output_1 - 10	Look up table Output	%	int	no	0	-100.. 100	yes

Table 2.6 Linearization

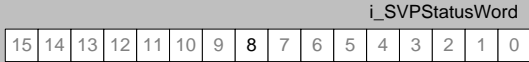
### SCP Integer Parameters

Address	Name	Description	Unit	Type	Scope	Default	Range	Stored in Flash
P 1999.0	Actual_Value_Path_Switch	Channel of the actual value	[0, 1]	int	yes	path 0	[0, 1]	yes
P 1999.1	DD_ON_Delay	Delay time to switch the DD factors active	ms	int	yes	0	0...10000	yes
P 1999.2	DD_OFF_Delay	Delay time to switch DD the factors to 1	ms	int	yes	0	0...10000	yes
P 1999.3	DD_Switching_ON_Time	Time to change the factor from 1 to DD	ms	int	yes	0	0...10000	yes
P 1999.4	DD_Switching_OFF_Time	Time to change the factor from DD to 1	ms	int	yes	0	0...10000	yes
P 1999.5	DD_Digital_output_Logic	DD_ON_OFF relay output logic	list	int	yes	1	0 ... 2	yes
P 1999.6	X4_Cable_Break_Detection	Activation of the cable break detection	-	int	yes	0	0 ... 3	yes
P 1999.7	X4_Analog_Input_Inversion	(Value substitution list) 0 = no input inverted 1 = iea 0 inverted 2 = iea 1 inverted 3 = both analog inputs inverted	-	int	yes	0	0 ... 3	yes
P 1999.8	Switching_On_SCP_Controller	0 = normal Position Controller 1 = SCP Speed Controller with field-bus-Interface 3 = SCP Speed Controller with analog interface <b>Note: A value change of this parameter will be active when power Stage is disabled.</b>	[0,1]	int	yes	0	0 ... 1	yes

Table 2.7 SCP Integer Parameters

### Predefined parameter sets

Address	Name	Description	Unit	Type	Scope	Default	Range	Stored in Flash
P 596.0	00_Proportional_Gain	Proportional gain	factor/10000	int	no	0	-max ... max	yes
P 596.1	00_Derivative_Gain	Differentiator gain	s/10000	int	no	0	-max ... max	yes
P 596.2	00_Derivative_t	Differentiator time	ms/1000	int	no	0	0 ... max	yes
P 596.3	00_Derivative_I_Gain_Pos	Differentiator positive gain; pressure loop	s/10000	int	no	10	-max ... max	yes
P 596.4	00_Derivative_I_Gain_Neg	Differentiator negative gain; pressure loop	s/10000	int	no	10	-max ... max	yes
P 596.5	00_Derivative_I_t	Differentiator time; pressure loop	ms/1000	int	no	2000	0 ... max	yes
P 596.6	00_I_Gain	Integrator	1/s/10000	int	no	10	-max ... max	yes
P 596.7	00_P_Integrator_Feedback	Integrator feedback gain	factor/10000	int	no	0	-max ... max	yes
P 596.8	00_DD_ON_OFF	ON: dual displacement factors active	List	int	no	off	[0, 1]	yes
P 596.9	00_Q_Command_Min_Static	Minimum flow; p and Q ctrl.	%	int	no	-100	-100 ... 100	yes
P 596.10	00_Actual_value_Path_Switch	Channel of the actual value	[0, 1]	int	no	path 0	[0, 1]	yes
P 596.11	00_Derivativ_Observer_Gain	Gain of observer input at differentiators	1/10000	int	no	0	-100000 – 100000	yes

Table 2.8 Predefined parameter sets

Parameter Set No.	Parameter No.
0	P 0596.0 ... P0596.15
1	P 0596.16 ... P0596.31
2	P 0596.32 ... P0596.47
3	P 0596.48 ... P0596.63
...	...
14	P 0596.224 ... P 0596.239

Table 2.9 Parameter set numbers



Note: Value range of predefined parameter sets will not be checked by DRIVEADMINISTRATOR.

## 4 Basic controller setup

### 4.1 Preparation for Setup



Note: Before starting with the SCP controller, the hardware, the current control and the speed control of the motor has to be set up. To run the MSD without SCP controller please refer to the MSD Servo Drive Operation Manual.



Note: It is possible to switch between SCP controller and standard speed controller by parameter **Switching\_On\_SCP\_controller (P 1999.8)**.



Attention: The dual displacement part of the software uses the brake output as a digital output. For the use of the brake output parameter motor brake output X13/X20 needs to be set to 41 (**P 0125** in drive settings / I/O-Configuration / Motor brake output).



Attention: Before activating the pump, all relevant limitations and safety functions have to be parameterized.



Attention: Parameterize and start the new SCP with care! A wrong parameter can damage the SCP or the machine. Pay attention to the sign of the parameters to prevent positive feedback. All parameters are immediately active after changing.

#### Default parameters

Before the first start of the SCP software (transition to the state “operation enabled”) check over the predefined parameter set (**P 596.0-11**). After switching on the SCP actual parameters will be copied from the first parameter set (parameter set 0).

### Test Points

Tests points were created to monitor the behavior of the SCP. They can be shown on the digital oscilloscope in the DRIVEADMINISTRATOR. The following picture presents the main test points in the overall controller view. The green numbers corresponds to the Sub-ID of the parameter **P 1655** and to the name of the test point.

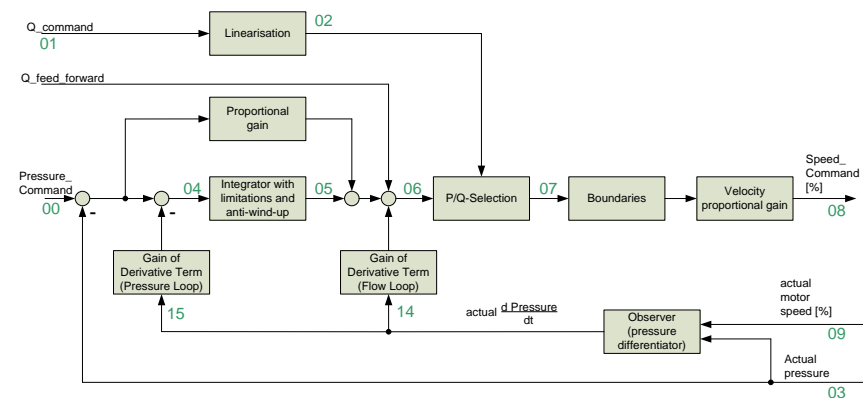

Fig. 4.1 SCP Controller test points

### Start-up preparations



Note: To adjust the input channel of the actual value, please refer to the chapter 5.5 Actual Value Path.



Note: To prove the controller calculation without active motor movement (e.g. to check the communication with sensors and controller) set the parameter **P 1998.12** to zero.

Before starting up the SCP necessary limits have to be set. The following table summarizes all limits in the SCP controller. The descriptions of these limits can be found in respective chapters.

Address	Name	Description
P 1996.11	Q_Command_Min_Static	Minimum Flow; p and Q control
P 1998.3	Cable_Break_Threshold_ISA0	Cable break detection threshold
P 1998.4	Cable_Break_Threshold_ISA1	Cable break detection threshold
P 1998.6	I_MAX_min	Integrator limitation
P 1998.7	I_MAX_max	Integrator limitation
P 1998.8	I_MIN_min	Integrator limitation
P 1998.9	I_MIN_max	Integrator limitation
P 1998.10	Speed_Rise_Rate_1	Maximum change of motor speed command
P 1998.11	Speed_Rise_Rate_2	Maximum change of motor speed command
P 1998.13	Pressure_Cavitation_Limit	Pressure cavitation limit
P 1998.15	Cavitation_Minimum_Velocity	Minimum velocity @ cavitation

Table 4.1 Limits in the SCP controller

Motor setup for speed control loop has to be done according to the MSD Servo Drive Operation Manual. The Motor must be able to run in a speed control loop. If this is not given, disconnect the pump from the motor and start the motor commissioning without connection to the pump.

After reattaching the pump to the motor adjust the pressure relief valve in the hydraulic system to the lowest possible setting to avoid system damage.

After setting the limits the main SCP parameters can be adjusted.

## 4.2 Main Parameters

In most cases it is enough to setup only the main parameters to achieve a good control performance. From the control point of view the main parameters are:

Parameter Number	Name	Description
P 1998.12	Velocity_Gain	Velocity proportional gain
P 1996.9	I_Gain	Integrator gain
P 1996.8	Derivativ_I_t	Time value of differentiator in observer
P 1996.6 (7)	Derivativ_I_Gain_Pos (_Neg)	Gain of derivative term in pressure control for positive and negative signal direction
P 1996.12	Derivativ_Observer_Gain	Observer gain

Table 4.2 Main parameters

The following chapters describe the effect of the parameters.



Note: To monitor the system behavior, please make use of test points (P 1655).

### Parameter: Velocity\_Gain (P 1998.12)

Velocity proportional gain calculates the percentage of revolution per minute [RPM/%]. There are pumps available for clock wise or counter clockwise rotation. At this point a right sign is important. The positive signal of the speed command (test point 08) corresponds to the flow which leads to pressure increase in the hydraulic system. If not, change the sign of the parameter velocity gain P 1998.12.

**Parameter: I\_Gain (P 1996.9)**

Integrator gain determines the dynamics of the controlled system. Higher I gain is desirable. The system reaction will be faster. However, if it's too high oscillations will occur.

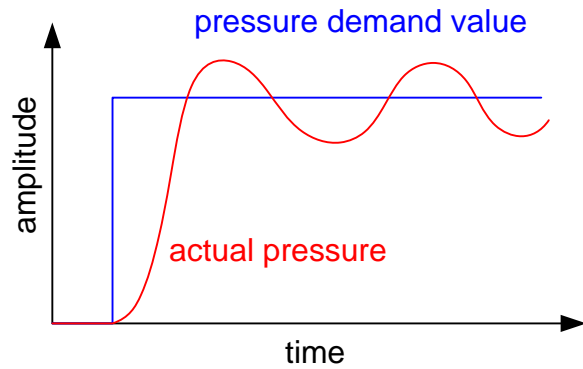

Fig. 4.2 I-Gain is too low

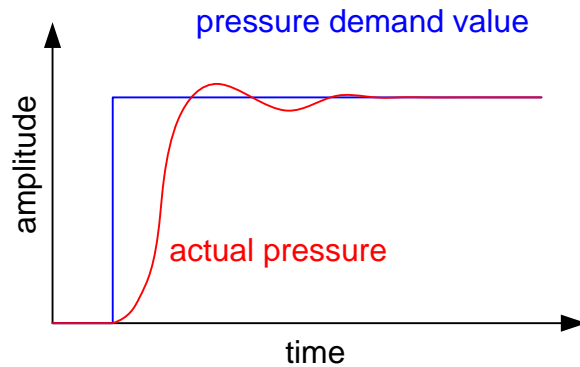

Fig. 4.3 I-Gain is well parameterized

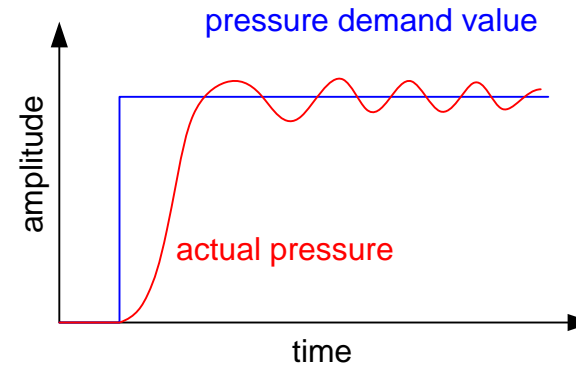

Fig. 4.4 I-Gain is too high

**Parameter: Derivative\_I\_t (P 1996.8)**

The smaller this parameter is the better. The differentiation runs faster and provides faster feedback. However, a faster differentiator has more noise in the output signal (monitor the test point 15).

**Parameters: Derivative\_I\_Gain\_Pos(\_Neg) (P 1996.6(7))**



Attention: System is sensitive to changes in this parameter. Change the parameter with care.

**Derivative\_I\_Gain** is an amplification of the differentiator. Generally this parameter is responsible for the stabilization of the integrator and for minimizing the overshoot. Note that it's possible to change the amplification for positive and negative pressure changing direction separately. However, in most cases they are the same.

### Parameter: **Derivative\_Observer\_Gain (P 1996.12)**

The differentiator receives a delayed signal because of piping and sensor delays. Thus, the stability margin is reduced. An observer can be used to overcome this issue. On the **Derivative\_Observer\_Gain** the motor speed is additionally included in the differentiation of the pressure to eliminate the delays caused by hydraulic capacities.

- **Derivative\_Observer\_Gain = 0**  
Observer works as a differentiator. The actual pressure will be differentiated.
- **Derivative\_Observer\_Gain > 0**  
The observer function (prediction) is turned on. The pressure derivative is additionally formed even with the actual speed. Dead time is eliminated, and the integrator gain can be further increased. System can be made even faster.

To set the **Derivative\_Observer\_Gain** the phase of the actual speed should be compared with the output of the differentiator. It is easy to do, since both signals are given in percentage. The aim is that the two signals are in phase with each other. The margin of stability is dominated by the phase lag between the two signals. Therefore the phase lag must be minimized.



Attention: Correct sign of parameter **P1996.12** is important for stability (compare with the sign of **P1998.12**)

The following examples illustrate the parameterization.





Fig. 4.5 Example behavior without observer (**Derivative\_Observer\_Gain** =0)  
A phase lag between the two signals is visible.

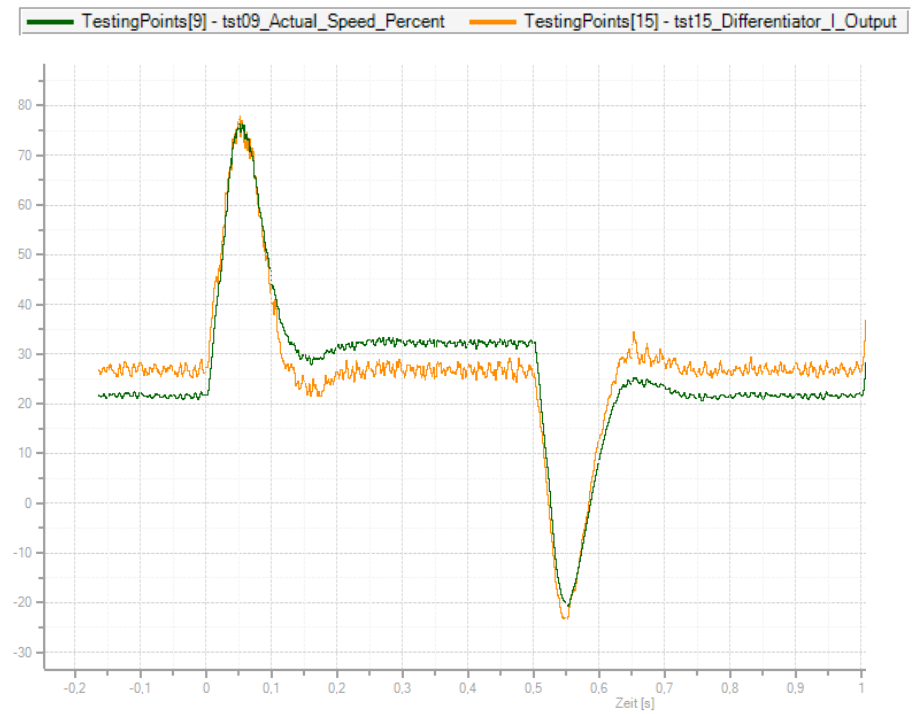

Fig. 4.6 I- Example behavior with well parameterized observer  
The two signals are in phase.

## 5 Advanced Controller Features

### 5.1 Linearization

The nonlinearity between speed and flow of the pump can be compensated. The linearization will be active if the parameter **Linearisation\_Number\_Elements** is greater than zero.

#### Setting up the parameters

Up to 10 values for each axis can be defined. The number of used values needs to be defined in parameter **Linearisation\_Number\_Elements**. Set this parameter to zero to switch the linearization off. Between the values, the output value is interpolated linear.

In the following figure shows an example with 6 interpolation points. In this example signals in a middle range (20 – 80 % amplitude) are weighted higher than signals around 0 and 100 %.

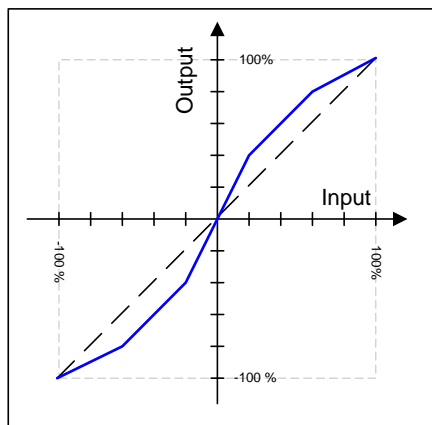

Fig. 5.1 Look –up table for linearization

The linearization parameters for the example above need to be set up as following:

Parameter Number	Name	Value
P 595.0	Linearisation_Number_Elements	6
P 595.1	Linearisation_Input_1	-100
P 595.2	Linearisation_Input_2	-60
P 595.3	Linearisation_Input_3	-20
P 595.4	Linearisation_Input_4	20
P 595.5	Linearisation_Input_5	60
P 595.6	Linearisation_Input_6	100
P 595.11	Linearisation_Output_1	-100
P 595.12	Linearisation_Output_2	-80
P 595.13	Linearisation_Output_3	-40
P 595.14	Linearisation_Output_4	-40
P 595.15	Linearisation_Output_5	80
P 595.16	Linearisation_Output_6	100

Table 5.1 Example linearization parameters

## 5.2 Dual Displacement

In case of using a dual displacement pump it is not necessary to adjust the controller separately for each displacement. Instead, the dual displacement function can be used. It switches the controller between two adjustable gains. All necessary parameters will be weighted by these gains automatically. The gains are saved in the parameters:

Address	Name	Description
P 1998.0	DD_Q_factor	Dual displacement Q factor
P 1998.1	DD_p_factor	Dual displacement p factor

Table 5.2 Dual displacement factors

A time delay before switching to the respective controller parameter reflects the delay that is caused by the pumps step response time. The time delay is shown in the following diagram (**DD\_ON\_Delay** and **DD\_OFF\_Delay**).

The dual displacement part of the software uses the brake output as a digital output. For the use of the brake output parameter Motor brake Output X13/X20 (**P 0125** in Drive settings / I/O-Configuration / Motor brake output) needs to be set to 41. It is possible to set one of the digital outputs to the same value (41) to monitor the output.

Digital output has to be adjusted according to the necessary output logic. The logic can be chosen using the parameter **DD\_Digital\_Output\_Logic**. A new Value in this parameter will affect the output value after switching the dual displacement Value using parameter **DD\_ON\_OFF** (**P 1997.3**).

Parameter	Value	Function
<b>DD_ON_OFF</b>	0	Digital output disabled
	1 (ANALOG IN 0)	Normal logic (digital output is switched on when dual displacement is switched on)
	2	Negative logic (digital output is switched off when dual displacement is switched on)

Table 5.3 Digital output logic

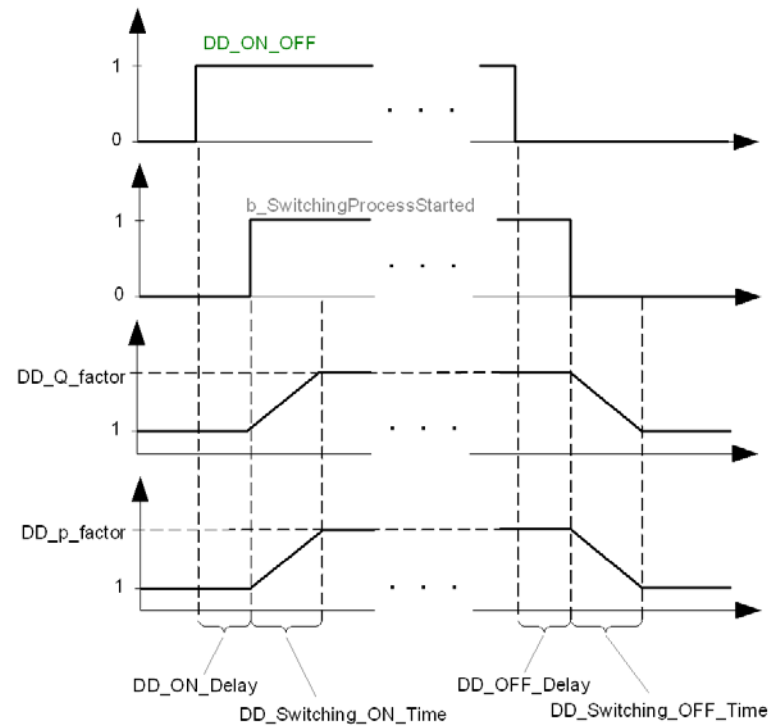

Fig. 5.2 Dual displacement

## 5.3 Parameter Switching Function

The SCP firmware can handle 15 different predefined parameter sets. These parameter sets are saved in the drive parameter **P 0596**, Sub-ID 0 - 239. Using parameter **Predefined\_Parameter\_Switch** a switching process will be started. 11 different parameters are defined:

Parameter Number	Name	Multiplier
0	Proportional_Gain	factor 10000 (*)
1	Derivative_Gain	factor 10000 (*)
2	Derivative_t	factor 1000 (*)
3	Derivative_I_Gain_Pos	factor 10000 (*)
4	Derivative_I_Gain_Neg	factor 10000 (*)
5	Derivative_I_t	factor 1000 (*)
6	I_Gain	factor 10000 (*)
7	P_Integrator_Feedback	factor 10000 (*)
8	DD_ON_OFF	boolean (**)
9	Q_Command_Min_Static	factor 1
10	Actual_Value_Path	boolean (**)
11	Derivative_Observer_Gain	factor 10000 (*)

Table 5.4 Predefined parameters

(\*)These parameters are divided by the value in the column “Multiplier” during the copying process.

(\*\*) Binary parameter. Possible Values: 0 = off, 1 = on.

Example: To maintain a **Proportional\_Gain** value of 1.234 you need to store 12340 as the predefined value. This value is divided by the factor of 10000 during the switching process and 1.234 is maintained in the **Proportional\_Gain** parameter.



**Attention:** During switching on the SCP controller the actual parameters will be copied from the parameter set No. 0 (**P 0596.0 – P 0596.15**). Changes in the SCP Floating Point Variables wouldn't be saved.

### Switching between different parameter sets

The active parameter set is chosen according to the parameter **Predefined\_Parameter\_Switch** (**P 1997.0**) and the state of the digital inputs ISD03 – ISD06. If the bit coded sum is above 14 then parameter set 14 will be selected. The switching mechanism is independent of the drive state (power stage enabled / disabled)

ISD06	ISD05	ISD04	ISD03	Chosen Parameter Set, in case Predefined_Parameter_Switch is zero.
Low	Low	Low	Low	0
Low	Low	Low	High	1
Low	Low	High	Low	2
Low	Low	High	High	3
Low	High	Low	Low	4
Low	High	Low	High	5
Low	High	High	Low	6
Low	High	High	High	7
High	Low	Low	Low	8
High	Low	Low	High	9
High	Low	High	Low	10
High	Low	High	High	11
High	High	Low	Low	12
High	High	Low	High	13
High	High	High	Low	14

Table 5.5 Choosing of parameter set

## 5.4 Protect Features

### Cavitation protection

The related parameters to the cavitation protection are

- **Pressure\_Cavitation\_Limit (P 1998.13)**
- **Cavitation\_Minimum\_Velocity (P 1998.15)**

There is a risk of cavitation if the pressure in the system goes under a certain level – **Pressure\_Cavitation\_Limit (P 1998.13)**. In such a situation cavitation protect will be active and the predefined minimum speed will be set.

The following example describes the functionality of cavitation protection: there is a cavitation risk and the pump speed needs to be decrease fast. The integrator in the pressure loop is on the lower limit and needs time to come up. In this situation cavitation\_limit will be active and overwrites the integrator output with the cavitation minimum velocity **Cavitation\_Minimum\_Velocity (P 1998.13)**.

### Integrator limits and anti-wind-up

Anti-wind-up can limit the integrator for stability reasons. **I\_MIN\_max(min)**, **I\_MAX\_max(min)** are the boundaries in which the limit can be set by the anti-wind-up. The lower limitation is allowed in the boundaries between **I\_MIN\_max** and **I\_MIN\_min** (e.g. from 0 % to -100 %, default values). The upper limitation is between **I\_MAX\_max** and **I\_MAX\_min** (e.g. from 100 % to 0 %, default values). Additional positive limit can be increased by using parameter **I\_MAX\_Offset**. However, it is recommended to keep this parameters default value.

### Rate limitation

The parameters **Speed\_Rise\_Rate\_1 (2) (P 1998.10(11))** defines the limit of the motor acceleration, also called Rate Limitation.

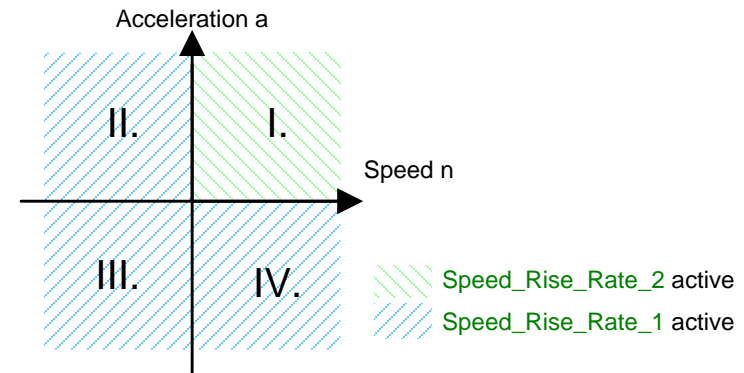

Fig. 5.3 Rate limitation quadrants

In the quadrants II, III and IV the physical limit of the acceleration is given only due to the mechanical characteristic of the pump. These quadrants are less critical. On the other hand there is a risk of cavitation in the supply pipeline in the quadrant I. Because of this, two **Speed\_Rise\_Rates** are given. The rate limitation provides the limited speed command output. Moreover, it provides a signal to anti-wind-up function of the integrator, so called ACC. By using the test points 12 and 13 (**P 1655.12-13**) ACC limitation can be monitored.

## 5.5 Actual Value Path

Depending on the state of **P1999.8** different analog inputs are used.

P1999.8 value	Input names	Ports
1 (SCP with Field bus Interface)	Actual pressure, input 1	MSD.AIN 0 (X4)
	Actual pressure, input 2	MSD.AIN 1 (X4)
	Other signals	field bus
2 (SCP with Analog I/O Interface)	Pressure command	MSD.AIN 0 (X4)
	Flow command	MSD.AIN 1 (X4)
	Actual pressure, input 1	MSD.AIN 2 (Option 2)
	Actual pressure, input 2	MSD.AIN 3 (Option 2)
	Pressure feedback	MSD.AOUT 2 (Option 2)
	Motor speed	MSD.AOUT 3 (Option 2)

Table 5.6 Actual value path

Cable break detection is available for analog inputs. For Voltage inputs ( $\pm 10$  V) this cable-break-detection is described in chapter Cable Break Detection. For current inputs (0-20 mA / 4-20 mA) a standard MSD Servo Drive function will be used, please refer the AIO Option Card Manual.

In case actual values are connected to X4, actual value path has the following structure.

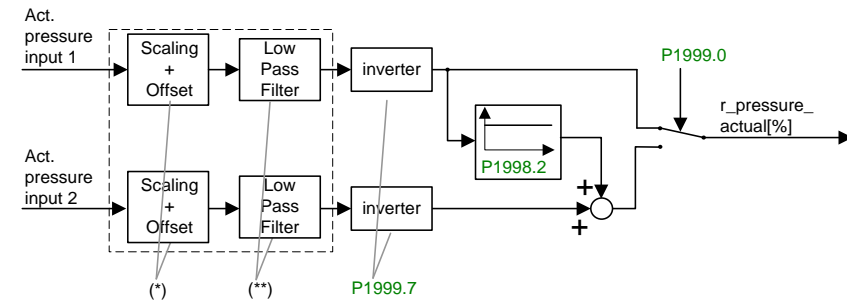

Fig. 5.4 Structure of actual value path

(\*) Gain and offset of analog inputs can be set in parameters **P 0428** and **P 0429**. A gain of 1 in **P0428** will result in a pressure value of 100 % if 10 V are applied at analog input 1. New values are accepted after disabling / enabling the drive.

(\*\*) Low pass filter time can be set in MSD parameters **P 0405** and **P 0406** (using the Moog DRIVEADMINISTRATOR). New values are accepted after disabling / enabling the drive.

In case actual values are connected to optional I/O card, identical structure will be used. However, the parameters to adjust gain, offset and filter are different. In this case please refer to AIO Option Card Manual.

## 5.6 Cable Break Detection

The cable break detection will generate an error if the signal of one of the analog inputs is outside of an allowed range. This detection is only active if the power stage of the MSD Servo Drive is enabled.



Note: The SCP cable break detection is designed for Inputs at the front connector X4 and for voltage inputs only. For analog current inputs (0-20 mA / 4-20 mA) use the build-in cable break detection mechanism. Please refer the AIO Option Card Manual for details. In this case set the parameter **Cable\_Break\_Detection (P 1999.6)** to zero (no detection).

The cable break detection can be activated using parameter **Cable\_Break\_Detection (P 1999.6)**. The following values are possible:

Parameter	Value	Function
<b>P 1999.6</b>	0 (no detection)	Function is not activated
<b>P 1999.6</b>	1 (ANALOG IN 0)	Function is activated only for first analog input
<b>P 1999.6</b>	2 (Analog In 1)	Function is activated only for second analog input
<b>P 1999.6</b>	1 (Analog In 0)	Function is activated for both analog inputs

Table 5.7 Cable break detection

If the cable break detection is enabled and the value of the analog input (after internal scaling) is in the area of the cable break threshold value an error will be generated:

Cable break detected at analog input 1: Error 52-03.

Cable break detected at analog input 2: Error 52-04.

The threshold for a failure reaction can be set up using the parameters **Cable\_Break\_Threshold\_ISA0** and **Cable\_Break\_Threshold\_ISA1**. The scale of these parameters is [%] - so a value of 10 % means 1 V for 0-10 V Voltage input.

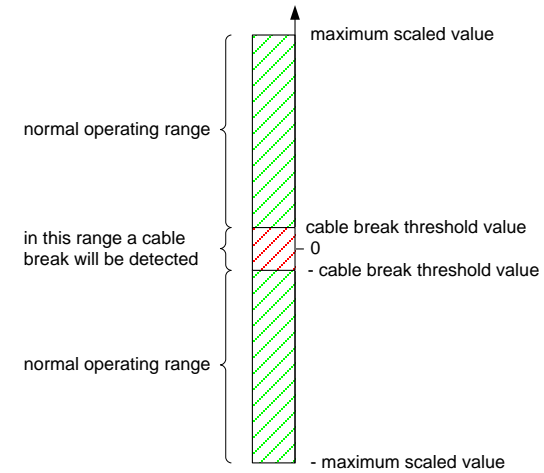

Fig. 5.5 Scaling of the cable break detection



Note: The Failure reaction can be selected in parameter **P 0030** Sub-ID 52. This parameter value must not be ignored. Setting 4 (Servo Halt with Quick-Stop) or 5 (Servo Halt with Quick-Stop and protection against restart) is recommended for the Speed Controlled Pump.

## 5.7 Leakage Compensation

The parameter **Leakage\_Compensation (P 1998.14)** has a dimension [speed / pressure]. The compensated Flow command will be calculated according to

$$q\_cmd\_mod = q\_cmd + Leakage\_Compensation * Pressure.$$

It means, even if external flow command is set to zero, some flow will be generated (Assuming pressure is not equal to zero). With the right parameterization this flow is equal to leakage.

## 5.8 Additional Options

Depending on the requirements, additional parameters as described below may be used to improve the system behavior. However, in most cases these parameters can be set to default values.

Address	Name	Description
<b>P 1996.3</b>	Proportional_Gain	Proportional gain
<b>P 1996.4</b>	Derivative_Gain	Differentiator gain; flow loop
<b>P 1996.5</b>	Derivative_t	Differentiator time value; flow loop
<b>P 1996.10</b>	P_Integrator_Feedback	Integrator feedback gain
<b>P 1996.11</b>	Q_Command_Min_Static	Minimal flow; p and Q control

Table 5.8 Additional options

**Proportional\_Gain:** This parameter describes the proportional gain in case of PI Pressure control (see Fig. 1.2).

**Derivative\_Gain** and **Derivative\_t** are the parameters of the d-term in the flow control loop. These parameters can improve the behavior of the flow controller.

Integrator behavior can be improved by internally using the additional feedback. The feedback gain can be adjusted by using the parameter **P\_Integrator\_Feedback**.

**Q\_Command\_Min\_Static** set the minimal limit of the pump flow. Be careful with the sign of this parameter.



## TAKE A CLOSER LOOK.

Moog solutions are only a click away. Visit our worldwide Web site for more information and the Moog facility nearest you.

### **MOOG**

Moog GmbH  
Hanns-Klemm-Straße 28  
D-71034 Böblingen  
Telefon +49 7031 622 0  
Telefax +49 7031 622 100

[www.moog.com/industrial](http://www.moog.com/industrial)  
[drives-support@moog.com](mailto:drives-support@moog.com)

Moog is a registered trademark of Moog, Inc. and its subsidiaries.  
All quoted trademarks are property of Moog, Inc. and its subsidiaries.  
All rights reserved.

© 2015 Moog GmbH

### **Technical alterations reserved.**

The contents of our documentation have been compiled with greatest care and in compliance with our present status of information.

Nevertheless we would like to point that this document cannot always be updated parallel to the technical further development of our products.

Information and specifications may be changed at any time. For information on the latest version please refer to [drives-support@moog.com](mailto:drives-support@moog.com).

Id no.: CB90332-001, Rev. 1.1

Date: 02/2017

Applicable as from firmware version:

The English version is the original of this specification